

DO NOT SCALE  
DIMENSIONS IN mm

METRIC

THIRD ANGLE  
PROJECTION

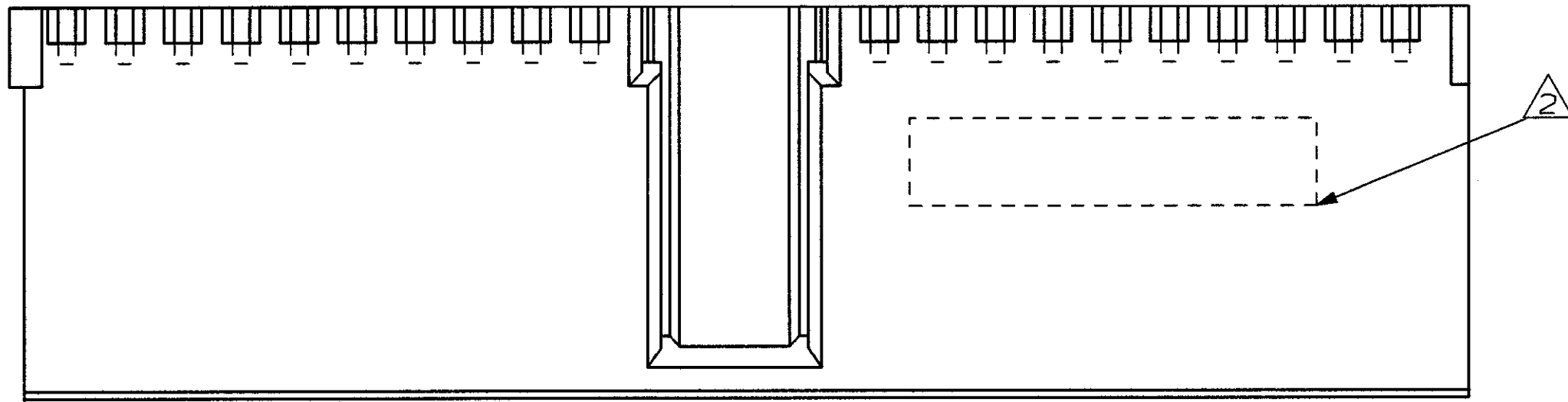

NOTES:

- 1 MATERIAL HOUSING: GLASSFILLED POLYESTER.
- 2 HOUSING PRINTED WITH PARTNUMBER AND DATE CODE.
- 3 AREA RESERVED FOR KEYING PART (BASIC P.N. 100525).

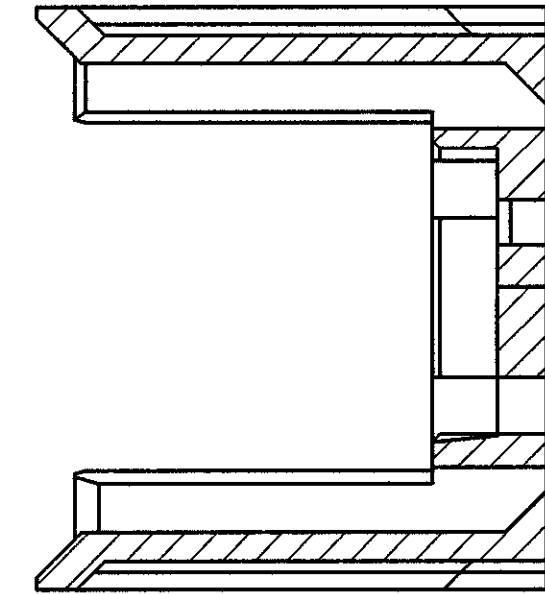
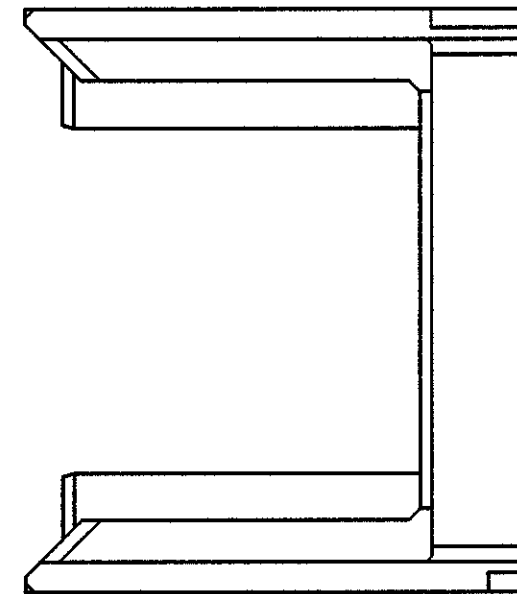
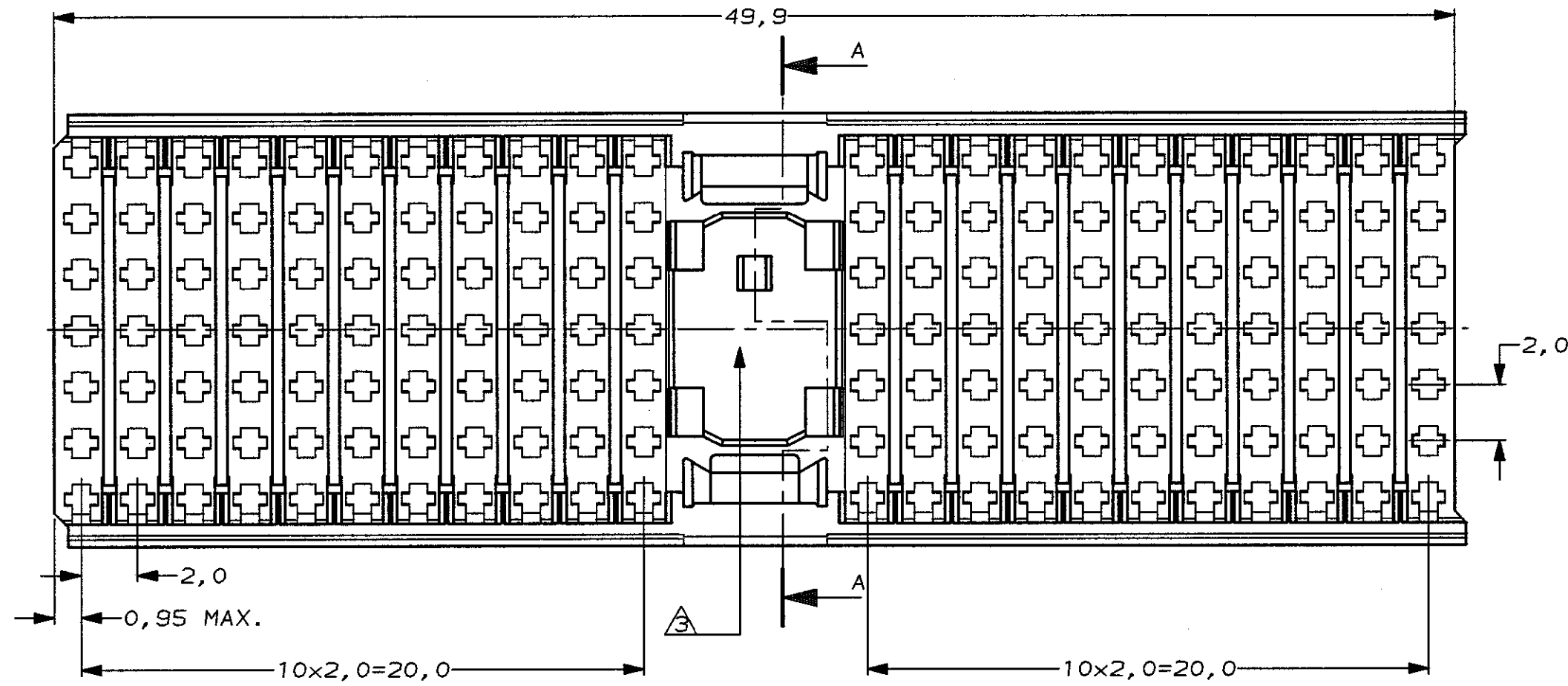

SECTION A-A

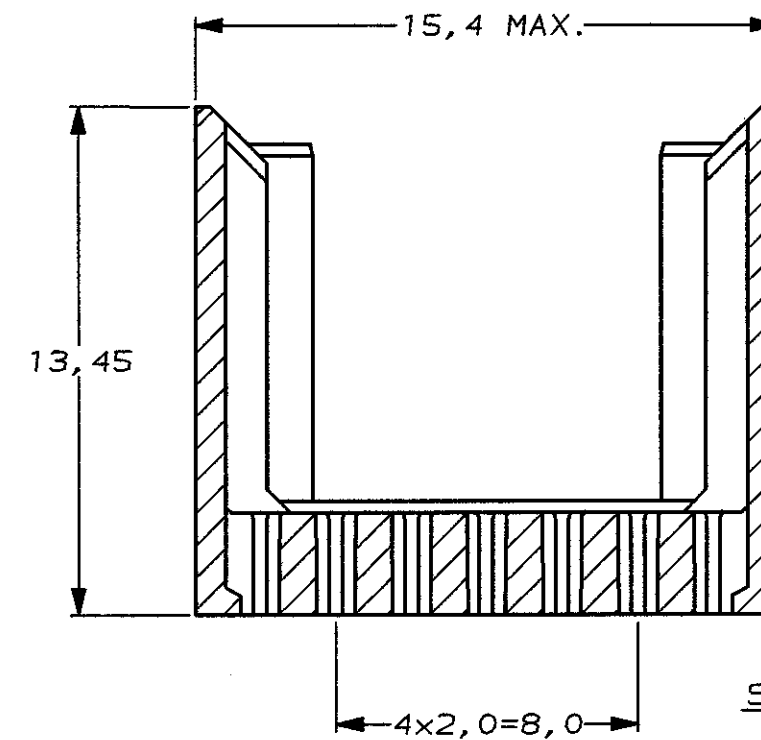
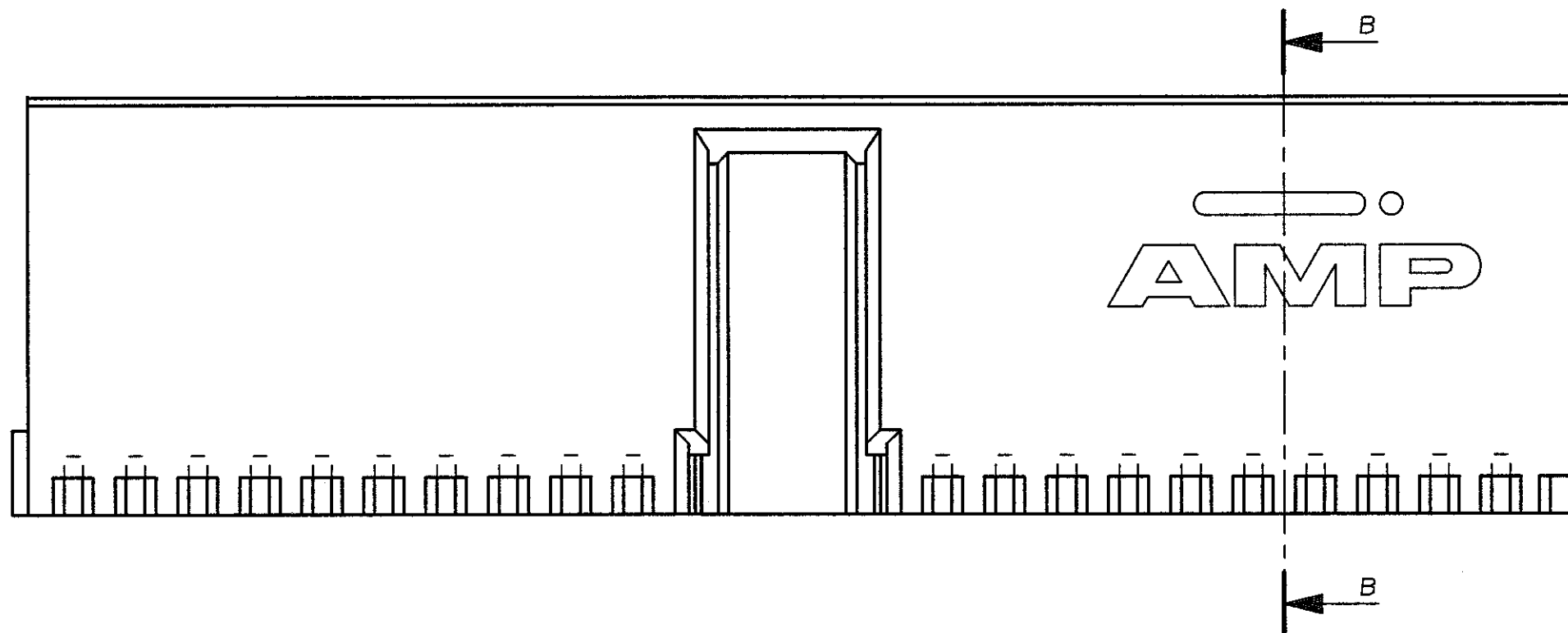

SECTION B-B

106137-2 AS SHOWN

FINISH		MATERIAL		PARTNUMBER	
-	-	-	-	CUSTOMER DRAWING FOR REFERENCE ONLY WILL NOT BE UPDATED	
© COPYRIGHT 1996 BY AMP-HOLLAND B.V. ALL INTERNATIONAL RIGHTS RESERVED. AMP PRODUCTS MAY BE COVERED BY U.S. AND FOREIGN AND/OR PATENTS PENDING.					
THIS DRAWING IS UNPUBLISHED AND/OR PATENTS PENDING.					
RELEASED FOR PUBLICATION					
C	EH-0764-96	DT	Fvk	21-JUN-96	 AMP-HOLLAND B.V. s-Hertogenbosch, The Netherlands.
B	EH-0238-93	LvdH	DS	2 JUNE '93	
A	EH-0081-93	S.M.	-	04-02-93	
O	H-10164	JvL	TS	30-11-92	
LTR. REVISION RECORD		DR.	CHK.	DATE	NAME
DR.: D. TRUREN		CHK.: F. KONINGSBERG	APP.: B. MOOIJ	DWG. No. C-106137	REV. LTR. C
DATE: 21-JUN-96		DATE: 21-JUN-96	DATE: 6-9-96	SHEET 1 OF 1	